

Zeitrelais

Socket and Accessories for Time Relays

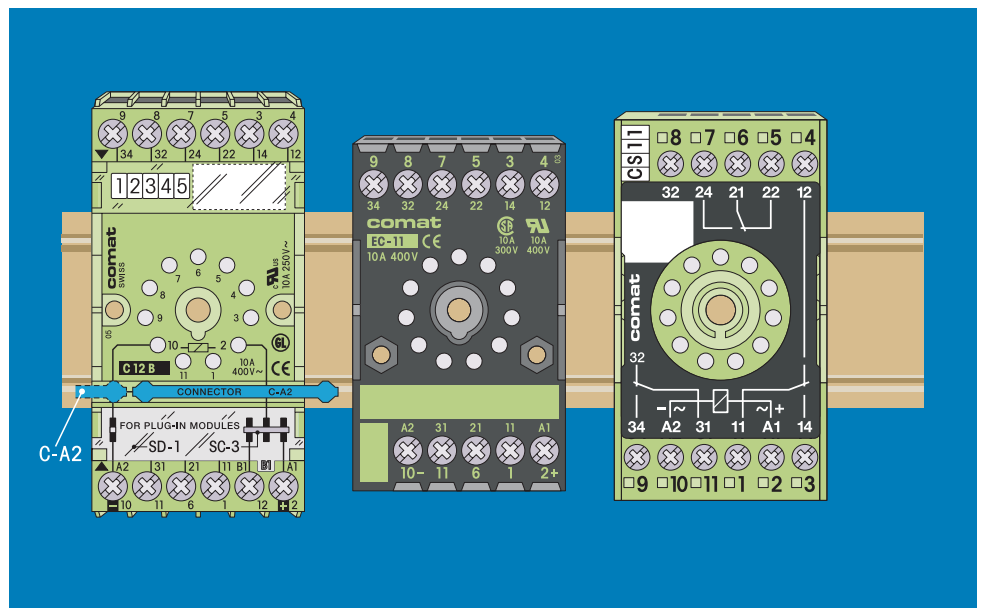

Socket for Time Relays

- Economy Socket
- System Socket
- Chassis Socket
- Socket accessories

Accessories for Time Relays

- External potentiometers
- In-house housing
- Diverses

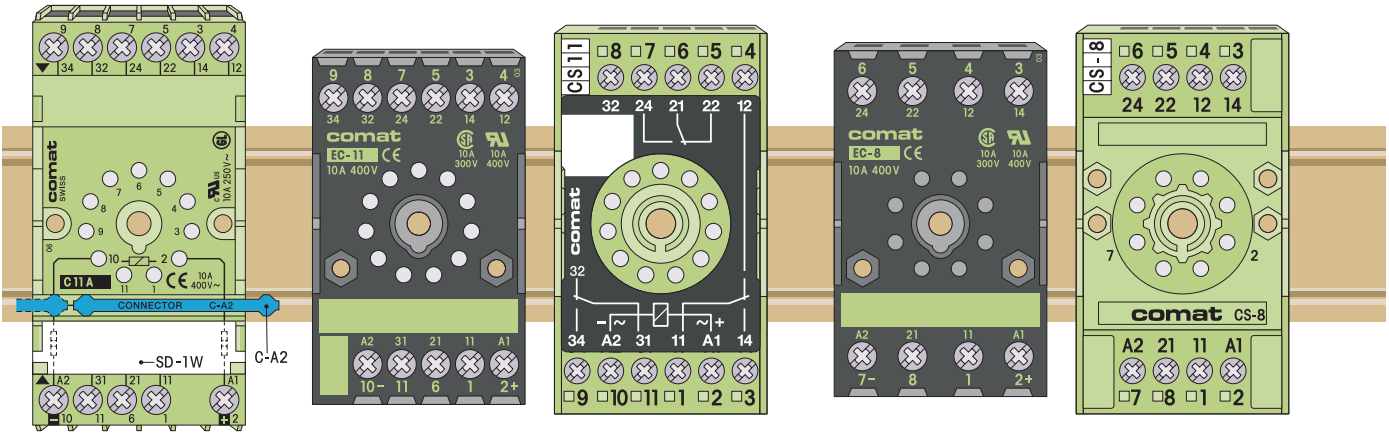

C11A

System-Socket 11-polig, mit Abdeckung weiss und steckbarem Verbinder C-A2. (Lieferumfang).

EC-11

Economy-Socket 11-polig

CS-11

Socket 11-polig mit aufgeschnapptem Geräteschema (Rückseite weiss neutral).

EC-8

Economy-Socket 8-polig

CS-8

Socket 8-polig

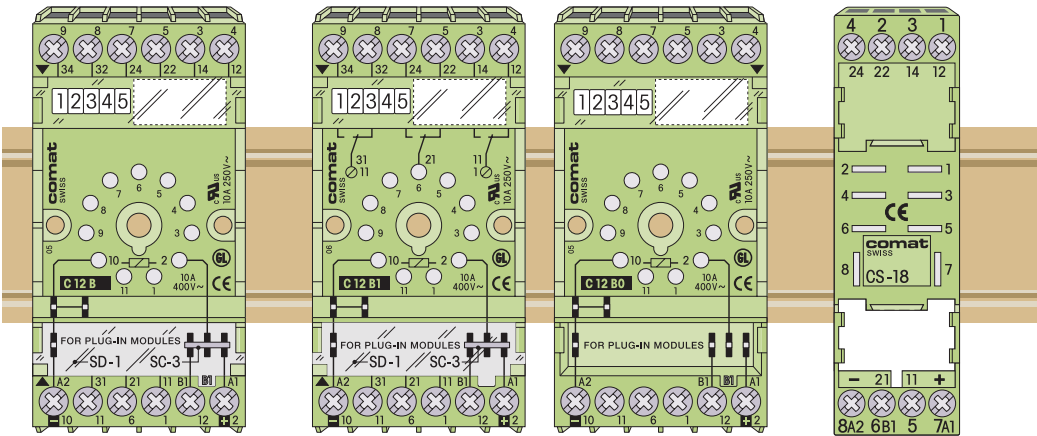

C12B

System-Socket 11-polig 12 Anschlüsse (+B1). SC-3 für B1-2-A1 gesteckt. Abdeckung transparent.

C12B1

System-Socket 11-polig, wie C12B, mit aufgedrucktem Kontaktbild für 3 polige Industrirelais.

C12B0

System-Socket 11-polig, ähnlich C12B. Vorbereitet für CT-System (ohne SC-3, SD-1).

CS-18

Socket 8-polig, für Zeitrelais C81...C85 Reihe

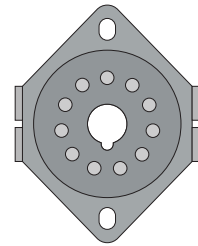

11 PGL

Socket 11-polig, Chassis-Socket mit Lötanschlüssen

Socket Typen		Passend zu Gerätefamilien			Anschlusslage (von links nach rechts)
		CT3... CS... C50... C60... RS... C... CX... SSR... CCX...	CT30...CT36	CT2	
C11A	System-Socket	●			A
EC-11	Economy-Socket	●			A
CS-11	Socket	●			B
C12B	System-Socket	○	○		A
C12B0	System-Socket		●		A
C12B1	System-Socket		○		A
CS-18	Socket			●	-
CS-8	Socket			●	-
EC-8	Economy-Socket			●	-
11 PGL	Chassis-Socket	○			-

A

B

● empfohlen
○ anwendbar

Sockel-Zubehör		Sockel Typen								
Typ	Beschrieb	C11A	EC-11	CS-11	C12B	C12B0	C12B1	EC-8	CS-8	CS-18
CA-11	Codier Ring (VE 5 Stück)			●						
CA-8	Codier Ring (VE 5 Stück)								●	
C-A2	Neutralleiter-Verbinder (VE 5 oder 50 Stück)	●			●	●	●			
SC-3	A1-Verbindungsstecker (VE 10 Stück)				●	●	●			
LH-1	Bezeichnungsschilder Träger (VE 5 Stück)	●			●	●	●			
SL-36	Bezeichnungsschild Halter (VE 5 Stück)			●					●	
SP-36	Beschriftungsstreifen (VE 5 Stück)			●					●	
PS-W	Beschriftungsstreifen (VE 5 Stück)									●
L-16	Beschriftungsstreifen (VE 5 Stück)	●			●	●	●			
SD-1	Verschlussdeckel transparent (VE 5 Stück)	●			●	●	●			
SD-1W	Verschlussdeckel weiss	●			●	●	●			
SS-T	Abdeckung transparent									●
SS-W	Abdeckung weiss									●
SA-0	Wand-Adapter									●

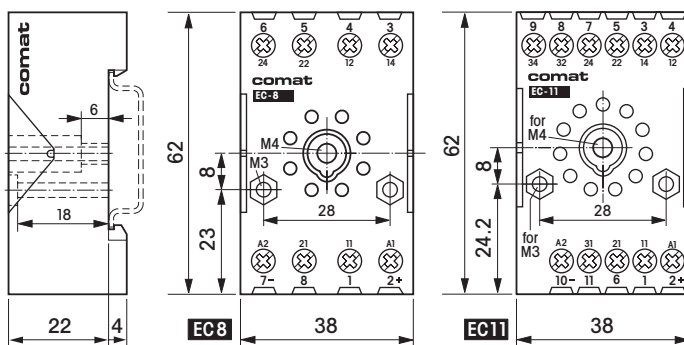
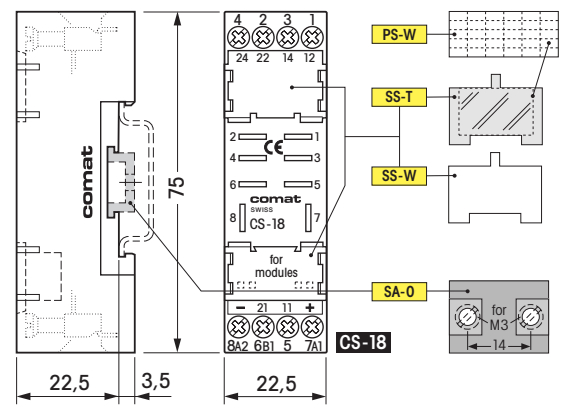
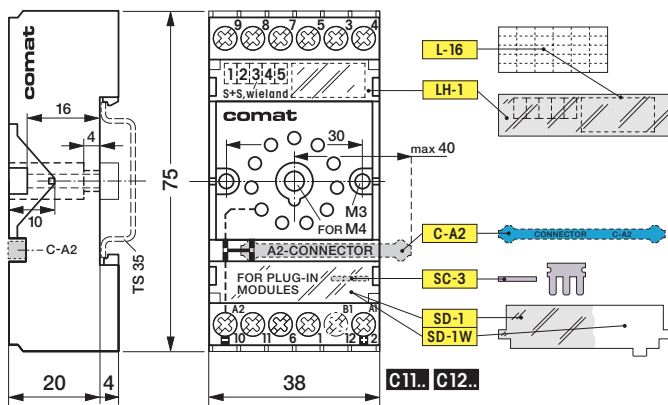
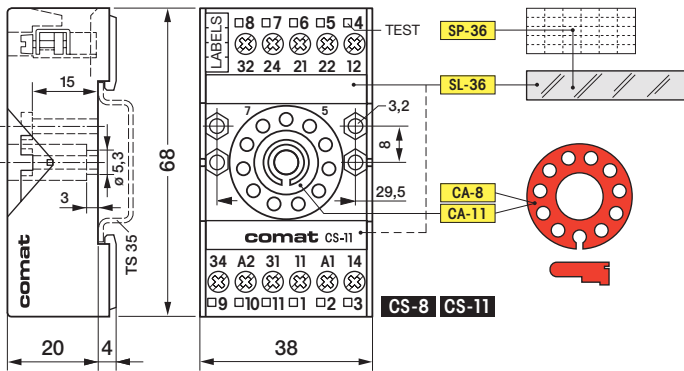

Externes Potentiometer

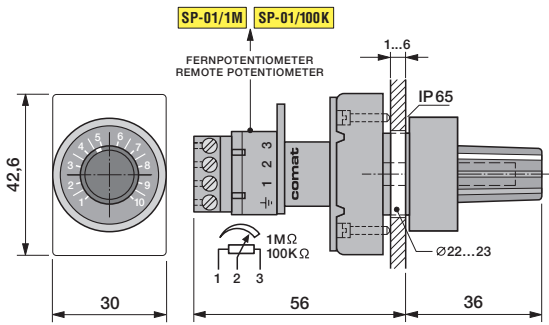

Fronteinbau FZ-50L

Bestehend aus Frontrahmen mit Abdeckung, Halbfeder und Sockel (11 PGL)

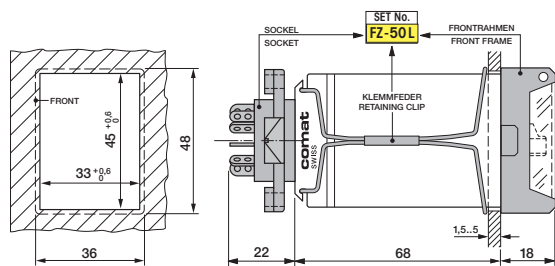

Fronteinbau FZ-23

Bestehend aus Frontrahmen, Abdeckung und Halbfeder

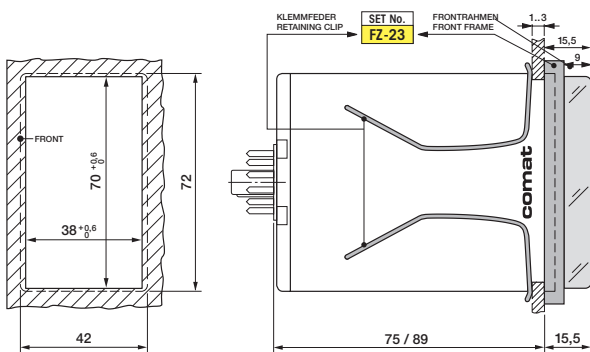

Fronteinbau FZ-40

Bestehend aus Frontrahmen und Halbfeder

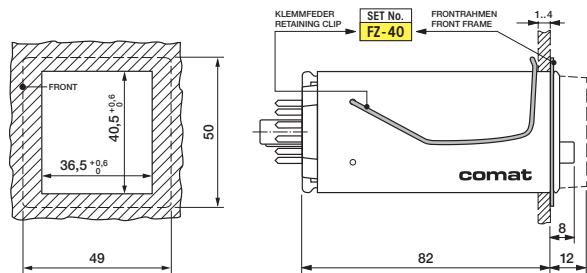

Beschriftungsschilder

Gross und Klein
 Für Relaisystem C13

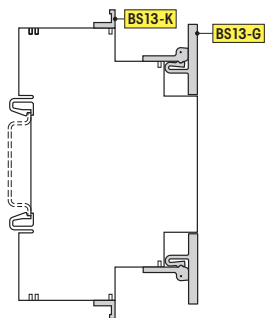

Frontabdeckungen

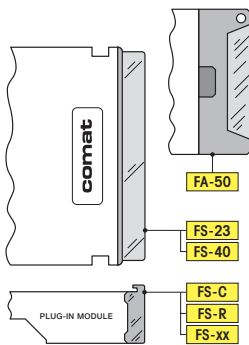

Halbfedern

Passend zu diversen Gehäusen und Sockel

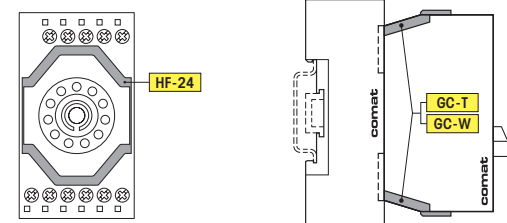

Halbfedern

Passend zu diversen Gehäusen und Sockel

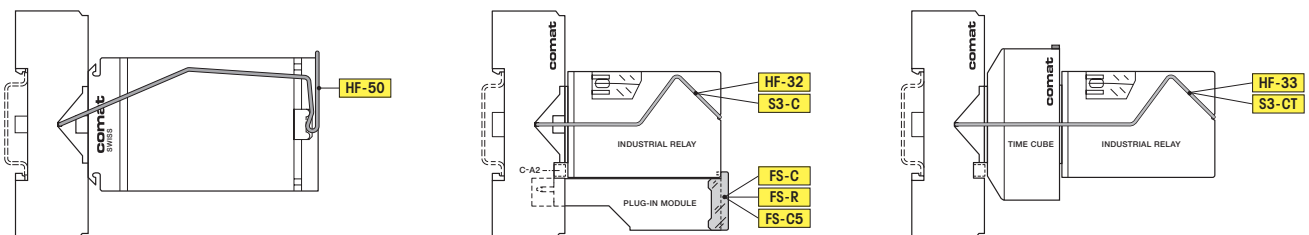

Externes Potentiometer				
Typ	Zeitrelais			
SP-01/100kΩ	CSV2	CM2		
SP-01/1MΩ	CS1	CS2	RS 121.P	CN 135

Zeitrelais-Zubehör und AP-Relaisgehäuse		Gerätefamilien										
Typ	Beschrieb	RS... C... CX CCX SSR	CS... C50... C60...	CT30...	RS 40	CT2...	CT3...	C80...	C13...	DIN A	DIN B/C	
BS13-G	Bezeichnungstreifen gross								●			
BS13-K	Bezeichnungstreifen klein								●			
FA-50	Frontabdeckung		●									
FS-23	Frontabdeckung	●										
FS-40	Frontabdeckung				●							
FS-C5	Adeckung zu Relais C30			●								
FS-R	Adeckung zu Relais C3-..			●								
FS-..	Adeckung zu Relais C5-..			●								
FZ-23	Fronteinbausatz	●										
FZ-40	Fronteinbausatz				●							
FZ-50L	Fronteinbausatz (inkl. Sockel 11PGL)		●									
GC-T	Relaishalterung transparent							●				
GC-W	Relaishalterung weiss							●				
HF-24	Haltefeder	●			●							
HF-32	Haltefeder für Relais C30			●								
HF-33	Haltefeder für Relais C20/C30					●	●					
HF-50	Haltefeder		●									
S3-C	Haltefeder für Relais C3			●								
S3-CT	Haltefeder für Relais C2/C3					●	●					
RG	Relaisgehäuse mit DIN-Schiene			●				●		●	●	
RG-D2	Relaisgehäuse mit DIN-Schiene									●		
RG-C2	Relaisgehäuse inkl. Sockel CS-8					●						
RG-C3	Relaisgehäuse inkl. Sockel CS-11						●					
RG-50	Relaisgehäuse inkl. Sockel CS-11		●									
RG-23	Relaisgehäuse inkl. Sockel CS-11	●										
RG-40	Relaisgehäuse inkl. Sockel CS-11				●		●					

AP-Relaisgehäuse mit eingebauter DIN Schiene oder mit Sockel (Schrauben berührungssicher)
Aus grauem Kunststoff, mit oder ohne Ausschnitt auf der Frontseite.

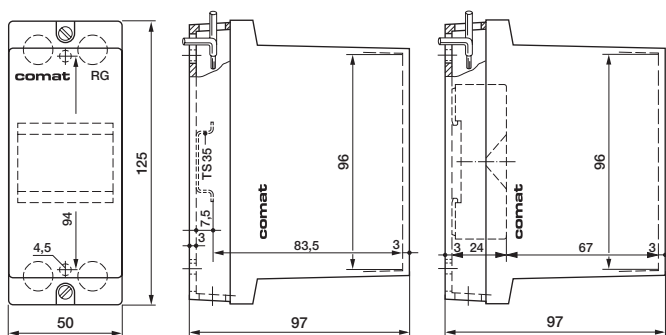

Typ	Socket	■ B x H
RG	DIN	---
RG-D2	DIN	21 x 46 mm
RG-C2	CS-8	36 x 36 mm
RG-C3	CS-11	36 x 36 mm
RG-50	CS-11	36 x 50 mm
RG-23	CS-11	39 x 73 mm
RG-40	CS-11	37 x 40 mm



Kühn Controls AG

Notizen:

wollen Sie mehr darüber wissen?... dann rufen Sie uns doch mal an!: Tel: +49 (0)7082-940000
oder senden Sie uns ein Fax: +49 (0)7082-940001, oder schreiben Sie uns ein
Email: sales@kuehn-controls.de oder besuchen Sie unsere Webseite: www.kuehn-controls.de